

# **CREST CRE57000 ON BOARD RADIO CONTROL SYSTEM**

# **TRAIN ENGINEER REVOLUTION**

## **INSTALLATION AND OPERATION MANUAL**

**This manual describes proper installation and operation of the following products:**

**CRE57001 REVOLUTION TRAIN ENGINEER 2.4 Ghz TRANSMITTER**

**CRE57002 REVOLUTION TRAIN ENGINEER 2.4 Ghz RECEIVER**

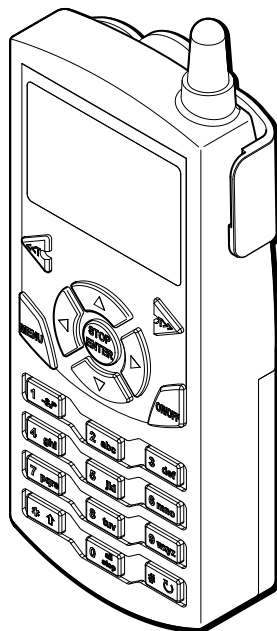
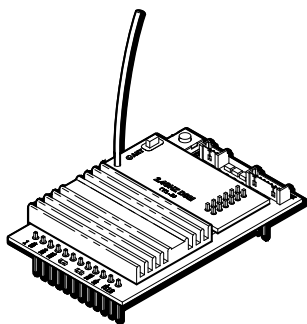

## **INTRODUCTION**

Congratulations on your purchase of the Crest Revolution Train Engineer wireless control system. This product has been manufactured to the highest standards using only quality components and, with proper care, will provide you with reliable service. The Revolution TE operates on the 2.4Ghz frequency band for ultimate stability and interference free operation.

The Revolution TE lets you walk around your model railroad layout and remotely control your locomotive speed, direction, lights, sounds, and smoke from up to 400 feet away. The Revolution TE was developed to provide the model train enthusiast with complete integrated control of their dream layout, without the need for complicated layout wiring or complex control panels.

The Revolution TE receiver is designed to operate between 12 to 24 volts applied either to the track or from on board batteries. The Receiver is designed for “plug and play” installation in any Aristo-Craft Locomotive with a DCC/RCC board. The receiver can also be installed in any large scale locomotive with the use of a supplied Adaptor Plug. General instructions for custom installations are included in this manual.

## **OPERATION OVERVIEW**

Before you start working with the Revolution TE there are a few concepts that you need to understand.

The transmitter and the receivers in your locomotives are designed to communicate and exchange information about the way you want your trains to operate. In order to establish a link between them you need to set up some basic parameters that define the locomotive for the Transmitter such as the locomotive’s name and road number. Once these parameters are set, the link between the transmitter and receiver is finalized by a process called “Linking”. Once linked, the transmitter and receiver are set to communicate and run your train. As you get comfortable with the Revolution TE, you can start fine tuning the optional settings for each locomotive. These options include setting the top speed that you want a locomotive to achieve, the rate at which you want it to accelerate, how long you want it to delay when the direction is changed, headlight operation and many more.

The second concept has to do with the Cab Assignment. Once you link a locomotive receiver to a transmitter you must set the Cab Number that the locomotive will run under. Cab Numbers range from CAB-0 through CAB49. This allows you to easily move between as many as 50 Single Unit locomotives and Multiple Unit Consists while operating your model railroad. CAB-0, CAB-1 and CAB-2 might be used to operate three different locomotives while CAB-3 can be used to operate those same three locomotives in a consist. Changing between Single Unit (SU) operation and Multiple Unit (MU) operation is as simple as selecting a Cab Number.

Once you have an opportunity to experience the process used to operate trains with the Revolution TE you will find that Aristo-Craft has found an elegant, easy to understand solution, to what can be a complex problem.

# CONTENTS

Features . . . . .	4
System Components . . . . .	5
Revolution TE Transmitter . . . . .	6
Revolution TE Receiver. . . . .	7
<b>BASIC OPERATIONS SECTION</b>	
Basic Receiver Installation (For Plug-N-Play Locomotives) . . . . .	7
Link Switch Installation. . . . .	9
Powering your Locomotives. . . . .	10
Transmitter Setup . . . . .	11
Basic Transmitter Programming. . . . .	11
Key Functions. . . . .	11
LCD Screen - Basic Reference guide. . . . .	12
Programming a Locomotive . . . . .	13
Setting The Cab Number . . . . .	15
Operating Your Locomotive . . . . .	16
Basic Troubleshooting Direction . . . . .	17
Basic Troubleshooting Headlights . . . . .	17
<b>ADVANCED OPERATIONS SECTION</b>	
Advanced Installations. . . . .	18
Auxiliary Control Harness . . . . .	18
CRE57073 Smoke Control Board Installation . . . . .	19
Advanced Programming And Functions . . . . .	20
Transmitter Operating Screen. . . . .	20
Menu Functions and Navigation . . . . .	23
1.ASSIGN FUNCTION . . . . .	23
2.USAGE OF CABS . . . . .	25
3.ADD MU/SU CAB. . . . .	26
Operating Multiple Locomotives In Consists (MUing). . . . .	27
4. COPY LOCO . . . . .	28
5. SYSTEM CONFIGURE . . . . .	28
6. RADIO CONFIGURE. . . . .	29
7. MY MEMO . . . . .	29
8. RESET MEMORY . . . . .	30
QUICK MENU LIST . . . . .	30
AUX FUNCTIONS . . . . .	30
STEP SPEED. . . . .	30
A->Z NAME SEARCH . . . . .	31
ABOUT SYSTEM . . . . .	31
Custom Receiver Installation . . . . .	31
Adaptor Plug Installation . . . . .	32
Headlight Connections (Incandescent) . . . . .	34
Headlight Connections (LED lamps) . . . . .	35
APPENDIX A - Text Entry Help . . . . .	36
APPENDIX B - Installation Records . . . . .	37

# **REVOLUTION TRAIN ENGINEER FEATURES**

## **SYSTEM FEATURES:**

- Spread spectrum radio transmission provides immunity from other radio sources
- Range exceeds 400 feet outdoors and 300 feet indoors.
- Continuous bidirectional 2.4Ghz communication between transmitter and receiver for smooth operation and operator feedback.
  - The active locomotive is shown on a graphical, backlit, LCD display
  - The receiver automatically shuts down if overload or overheating occurs
  - The error that causes a locomotive shut down is displayed on LCD display
- Locomotives are identified by name and road number
- Up to 6 locomotives can be linked together (MUed) into a consist
- Up to 10 MU consists can be setup and controlled by one transmitter
- Locomotives can be added or removed from an MU consist without relinking

## **TRANSMITTER FEATURES:**

- Large LCD graphic screen, backlit for night operation
- One handed operation
- Intuitive, simple data input is entered using cell phone style texting techniques
- Memory For Up To 50 Unique Locomotives On Each Transmitter
- Multiple transmitters can operate without interference with one another
- Simultaneous Single Unit 'SU' and Multiple Unit 'MU' operation
- All Stop Key to provide an emergency stop for all trains on a transmitter

## **RECEIVER FEATURES:**

- Plug and play installation in most Aristo-Craft locomotives
- On-board battery or track power
- Six auxiliary outputs on the receiver to control sound, smoke and lights
- 5 Amps continuous power with peak loads up to 8 amps
- Polarity protection
- Overload protection

## **INDIVIDUALIZED LOCOMOTIVE PROGRAMMABLE SETTINGS:**

- Programmable momentum control and forward & reverse delay
- Adjustable start speed
- Adjustable top speed
- Direction control headlights
- Direction control motor setting for MUing locomotives back-to-back.
- Function key assignment for six auxiliary outputs
- Copy locomotive settings for fast replication of similar locomotives

## **ADDITIONAL EQUIPMENT AVAILABLE SEPARATELY:**

- CRE57001 Revolution TE Transmitter
- CRE57002 Revolution TE Receiver
- CRE57073 Smoke Control Board
- CRE57076 Capacitor Board
- CRE57080 TX Battery NI-Cd Battery & Charger
- CRE57072 Transmitter Battery Charger (without batteries)

# CRE57000 SYSTEM COMPONENTS

The CRE57000 Crest Revolution TE Wireless Control System consists of the following components:

- CRE57001 Transmitter
- CRE57002 Receiver which includes a Remote Link Switch, an Auxiliary Control Harness and an Adaptor Plug
- CRE57073 Smoke Control Board.

CRE57002  
RECEIVER

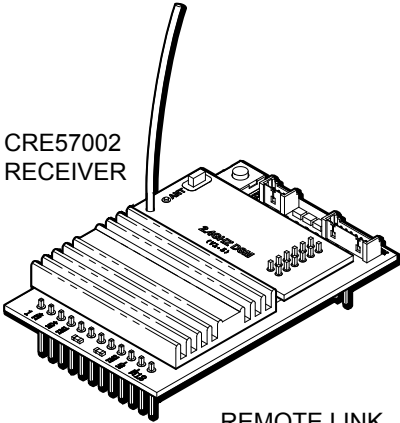

REMOTE LINK  
SWITCH

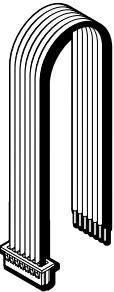
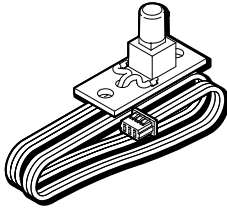

AUXILIARY CONTROL  
HARNESS

ADAPTER PLUG  
(for custom installations)

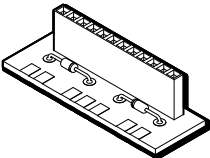

CRE57001 TRANSMITTER

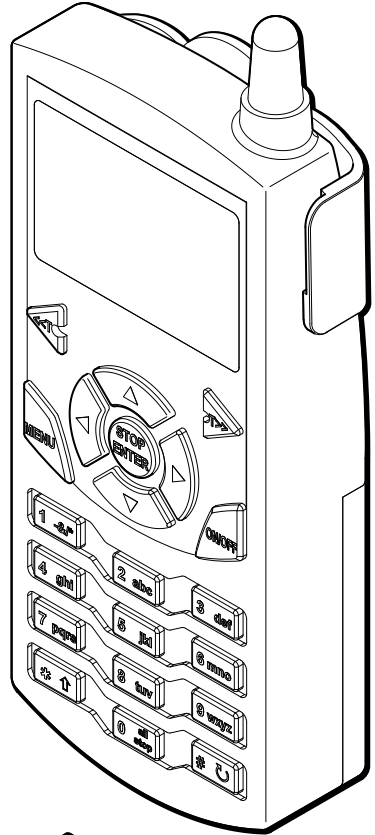

CRE57073  
SMOKE CONTROL  
BOARD

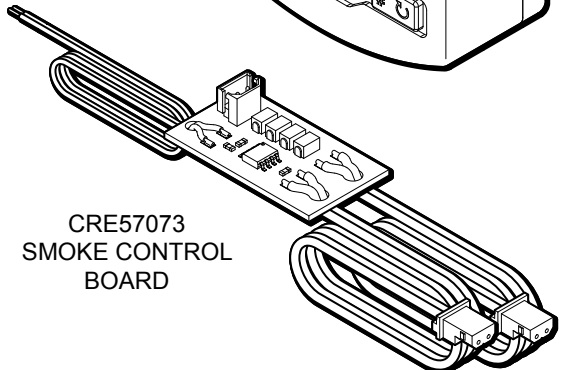

# REVOLUTION TE TRANSMITTER

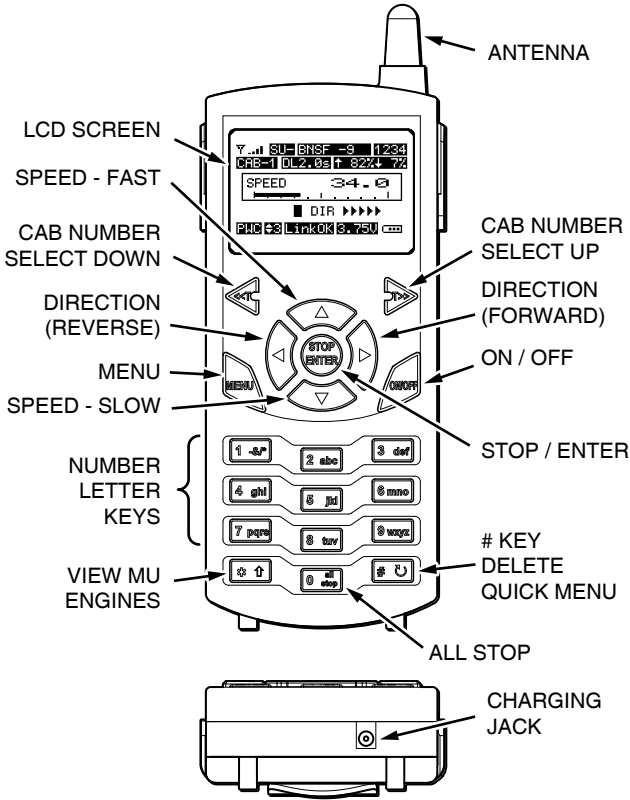

## LCD SCREEN

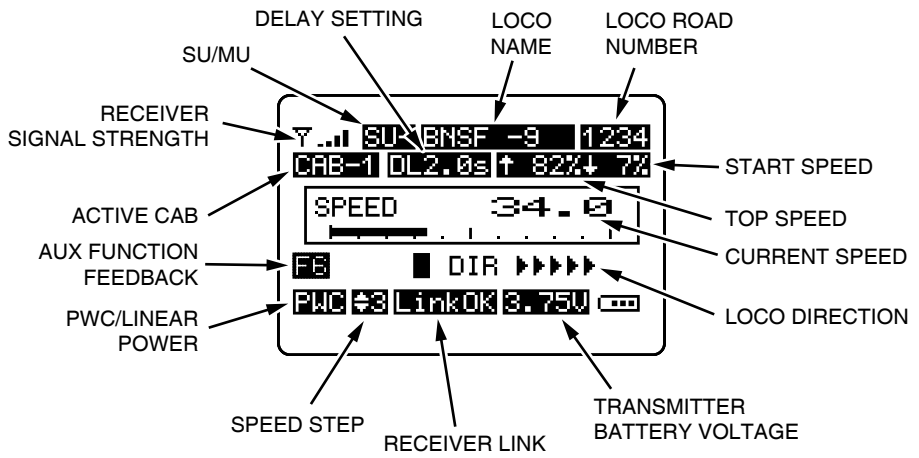

# REVOLUTION TE RECEIVER

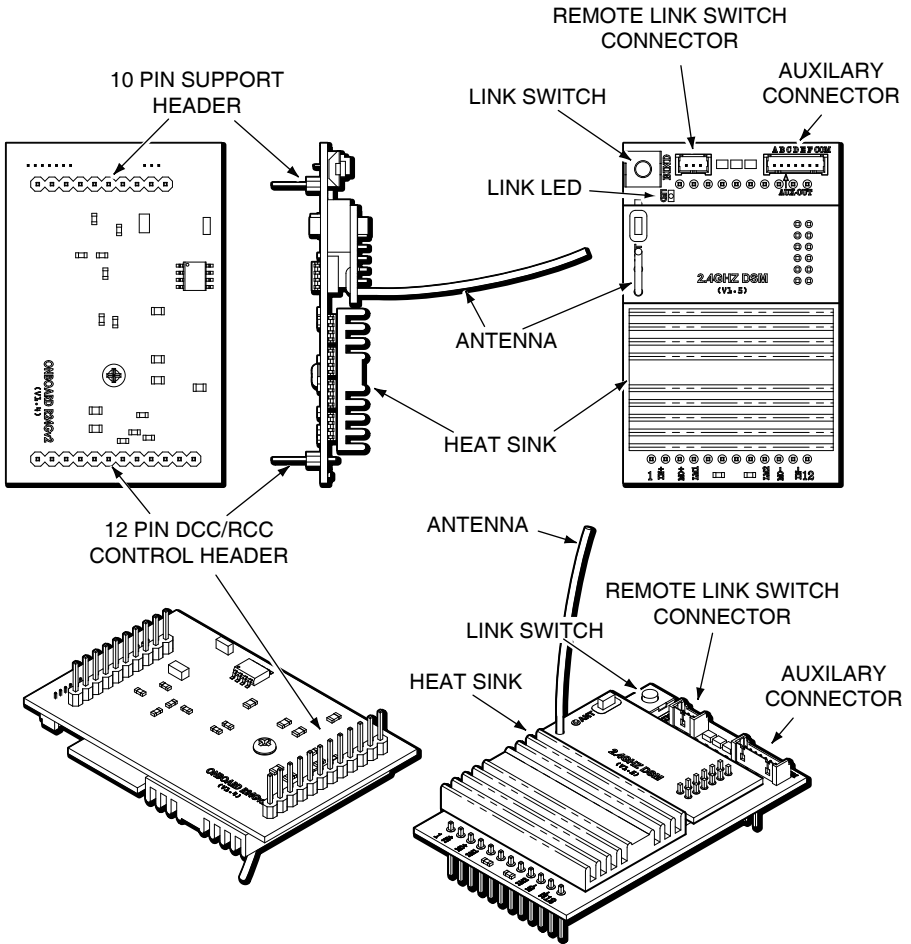

## BASIC RECEIVER INSTALLATION FOR PLUG-AND-PLAY DCC/RCC EQUIPPED LOCOMOTIVES

You will need the following items for installation:

- CRE57002 Revolution TE 2.4 Ghz Receiver
- REMOTE Link Switch
- Phillips head screwdriver
- A drill and drill bits to install the remote Link Switch (if desired)

**NOTE:** If the locomotive does not have a DCC/RCC compatible main circuit board, see the custom installation instructions beginning on page 31 of this manual.

- 1) Remove the locomotive shell. Refer to the manual included with your locomotive to determine where the DCC/RCC socket is located. Turn the locomotive (or tender) over, and remove all screws that hold the shell to the frame. Depending on the model of the locomotive, the number of screws will vary.
- 2) Remove the jumper plug on the DCC/RCC socket and set it aside. You can restore the locomotive to its pre-installation state by reinstalling the jumper plug.

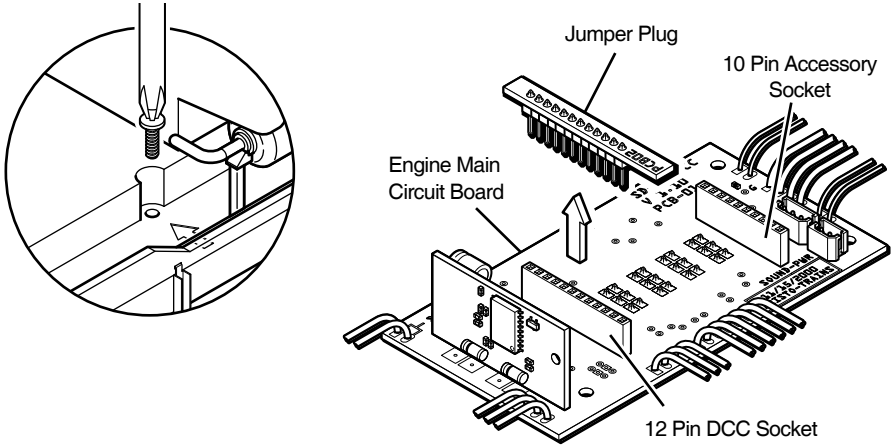

- 3) Install the receiver in the 12 pin DCC/RCC socket and the 10 pin support socket as shown making sure to match the 12 pin header to the 12 pin socket and the 10 pin header to the 10 pin socket.

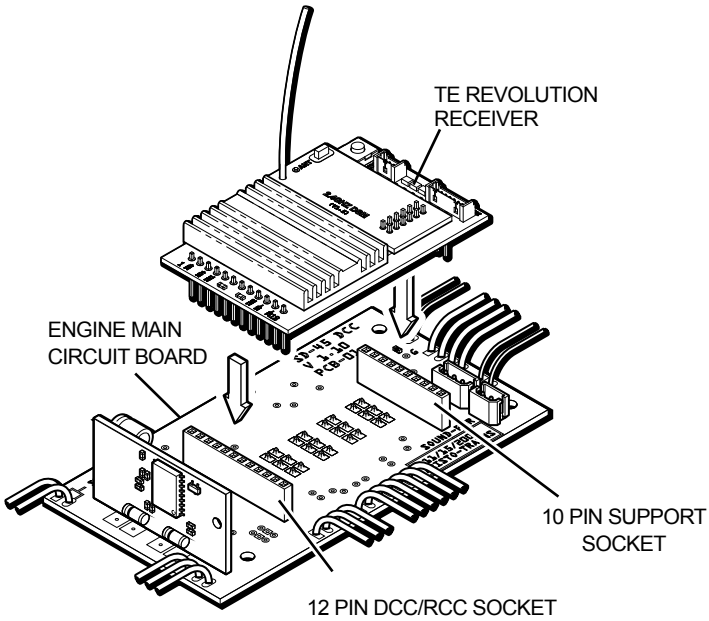



4) Install the Remote Link Switch

**NOTE:** There is a Link Switch on the receiver. If the Link Switch on the receiver is accessible from outside the locomotive you may wish to skip this step

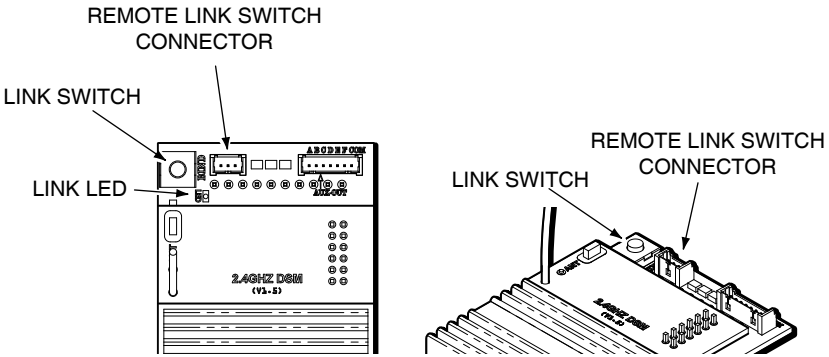

Locate a place to install the supplied Remote Link Switch where it will be accessible from the outside of the locomotive, yet obscured from view. Under a removable hatch or through the bottom of the locomotive or tender are convenient locations, in most cases. The Remote Link Switch must not be mounted on a metal or conductive surface since this may cause a short circuit.

**A typical installation in the Aristo-Craft SD45 is shown below.**

Drill a 5/16" (8MM) diameter hole in the selected location. Install the Remote Link Switch through the hole from inside and secure it with hot melt glue or silicone adhesive.

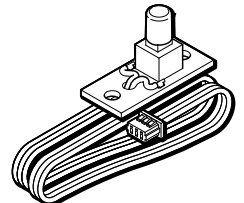

REMOTE LINK SWITCH

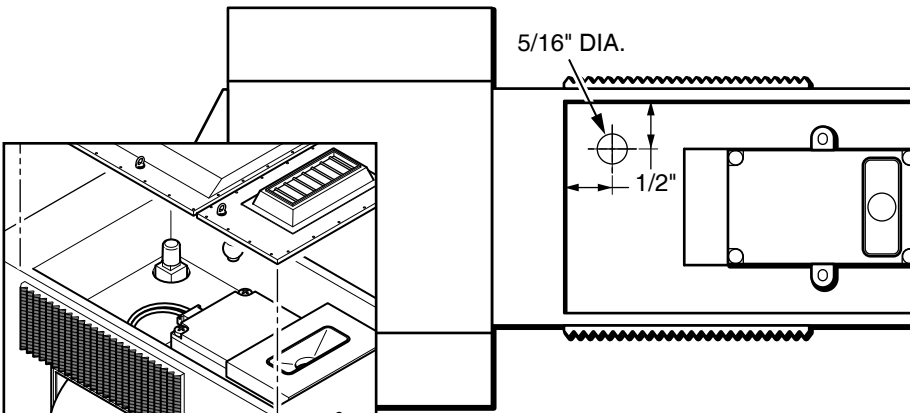

5) Attach the remote link switch connector on the Remote Link Switch to the three pin header on the receiver as shown on the following page.

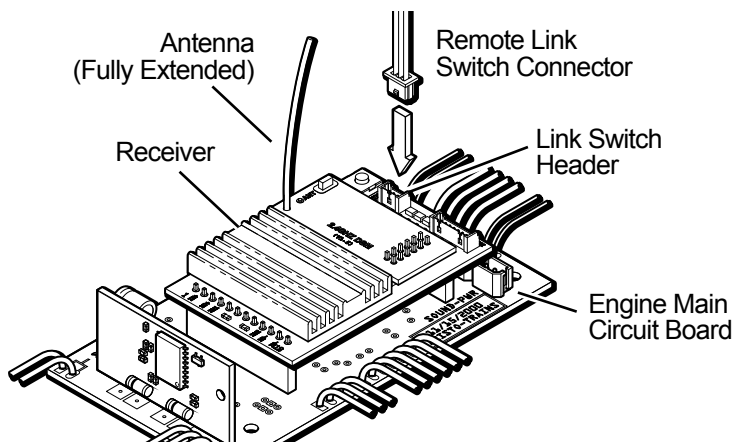

- 6) Reinstall the locomotive shell. Use care when reassembling the locomotive. Be careful that you do not pinch any wires between the shell and internal parts of the locomotive.

**THIS COMPLETES BASIC INSTALLATION OF THE RECEIVER.** After the Transmitter set-up is complete, you will have full remote control of your locomotive speed, direction and lights. If you wish to add advanced options such as remote operation of smoke and sound please refer to the advanced section later in this manual.

## POWERING YOUR LOCOMOTIVES

**TRACK POWER.** The Revolution TE receiver will work on voltages ranging from 12 to 24 volts DC. When running from track power, connect DC power directly to the track and set your controller power to the highest setting, but not more than 24 volts. You can also connect a DC power supply of up to 24 volts, without any speed controller, directly to the track. Set the track/battery switch on your locomotive to 'Track'.

**BATTERY POWER.** The Revolution TE receiver can also be powered from Li-Ion (Lithium Ion), Ni-MH (Nickel Metal Hydride), Ni-Cd (Nickel Cadmium) or Gel Cell batteries. The maximum voltage must not exceed 24 volts. Multiple batteries can be wired in series or parallel to increase voltage or run time. When operating from batteries, set the track/battery switch on your locomotive to 'Battery'. The following batteries and cables are available from Aristo-Craft dealers.

PART NUMBER	DESCRIPTION	CHARGER
CRE55610	Li-Ion, 2 AMP - 21.5 Volts	CRE55620
CRE55650	Ni-MH 2.8 AMP - 12 Volts	CRE55660
CRE55653	Ni-MH 2.8 AMP - 19.2 Volts	CRE55661
CRE57080	Ni-Cd 1.5 AMP - 12 Volts	CRE55660
CRE55493	Gel Cell 3.2 AMP - 3 X 6V	CRE55494
CRE55601	Auto Cutoff For Gell Cell Battery	
CRE55602	Wire Harness For Battery Set	
CRE55611	Y Plug In Parallel	
CRE55613	Y Plug in Series	

## TRANSMITTER SETUP

- 1) **REMOVE THE BATTERY COMPARTMENT COVER** on the back of the transmitter case.
- 2) **INSERT THREE “AA” BATTERIES** The Revolution Transmitter will operate on your choice of three “AA” Alkaline, Ni-MH (Nickel Metal Hydride) or Ni-Cd (Nickel Cadmium) batteries of 1.2 to 1.5 volts each. All three batteries must be identical, do not mix battery types. Insert the batteries making sure that they face in the directions indicated in the battery compartment.

Crest Battery Charger CRE57072, is available for charging Ni-Cd batteries through the charging port in the bottom of the transmitter.

- 3) **REPLACE THE BATTERY COMPARTMENT COVER**

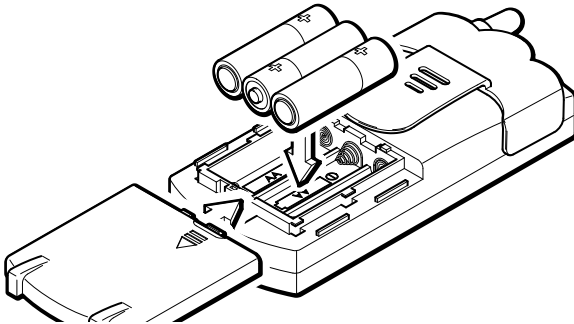

## BASIC TRANSMITTER PROGRAMMING PROCEDURE

The following section describes the basic programming necessary to begin running your trains with the Revolution TE system. Since the Revolution TE is an advanced and full featured system, you may wish to operate your trains at the basic level described here until you feel ready to take advantage of all of the features that the Revolution has available. The Revolution TE’s advanced functions are described in the advanced section of this manual.

Please take the time to familiarize yourself with the transmitter design, key and button layout as well as the transmitter’s LCD screen on the following pages.



**ON/OFF** - Press and hold the **ON/OFF** to turn the Transmitter on. Press and hold the **ON/OFF** to turn the Transmitter off.



**MENU** - Press **MENU** to select the Transmitter’s setup menus. While accessing menus, pressing **MENU** will move you back one level.

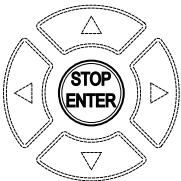

**STOP/ENTER** - When operating a locomotive the **STOP/ENTER** key will **STOP** the active locomotive and set its speed to zero. When accessing menu’s, the **STOP/ENTER** key will operate as an **ENTER** key to confirm a selection.



**ARROW Keys** - When operating a locomotive the up and down arrows (▲ and ▼) increase or decrease speed and the left and right arrows (◀ and ▶) select direction. When accessing menu items the up and down arrows (▲ and ▼) scroll between items and the left and right arrows (◀ and ▶) change that item's value.



<<T and T>> - Used to select the active locomotive Cab. Press the <<T key to scroll down and the T>> to scroll up the list. The locomotive names and road numbers will be displayed on the main operation screen.



**ALL STOP** - PRESS AND HOLD the "0 all stop" key and this immediately stops all locomotives on the same transmitter and sets their speed to zero. This key is also used to reset a locomotive after an overload or overheat error occurs.

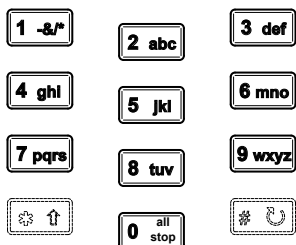

**NUMBER / LETTER KEYS** - Use when entering numeric or textual information the use of these keys is identical to those on a cell phone. When operating a locomotive, keys 1 through 6 are used to operate six auxiliary functions. For example, pressing key "1" might activate the horn sound. Programming these keys is covered in the advanced programming section of this manual.



**# (POUND)** - When the Operating screen is being displayed pressing the # key accesses the Quick Menu. During text entry, this is the 'space' key



**\* (STAR)** - When operating an MU consist, pressing this key selects the locomotive in the consist whose auxiliary functions, such as smoke or sound, that you want to control.

**LCD SCREEN** - Basic Reference guide

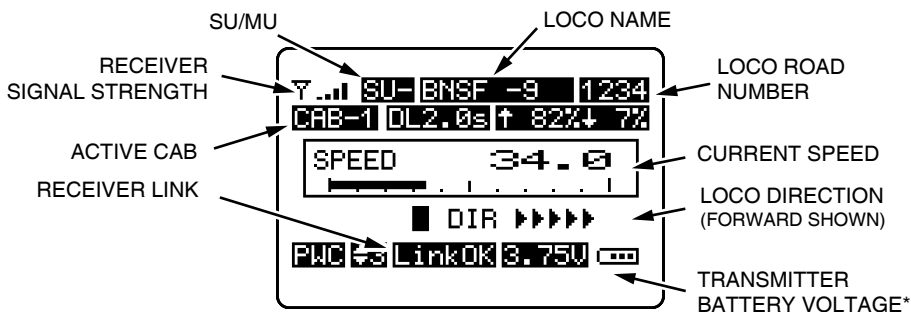

\*NOTE: THE TRANSMITTER WILL SHUT OFF WHEN THE BATTERY VOLTAGE DROPS TO 3.4 VOLTS.

## PROGRAMMING A LOCOMOTIVE

**OPERATION NOTE:** Use the ▲ and ▼ keys to highlight a menu option and then press **STOP/ENTER** to select the item.

The transmitter and the receivers in your locomotives are designed to communicate and exchange information about the way you want your trains to operate. In order to establish a link between them you need to set up some basic parameters that define the locomotive for the transmitter and for you, such as the locomotive's name and road number. Once these parameters are set, the link between the transmitter and receiver is finalized by a process called "Linking". Once linked, the transmitter and receiver are set to communicate. Finally you must assign a Cab Number to your locomotive and then you are ready run your train with the Revolution TE.

As you get comfortable with the Revolution TE, you can start fine tuning the optional settings for each locomotive, as described, in the advanced section of this manual.

- 1) Turn on the transmitter by pressing On/Off. The main "Operating" screen will be displayed.
- 2) Press MENU to access the MAIN SET UP menu.

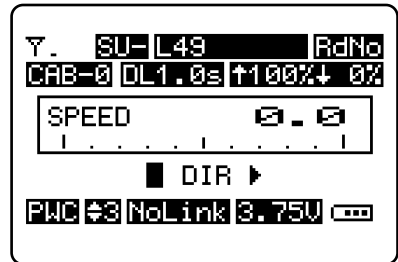

- 3) Press the STOP/ENTER key (or the '1' key) to select:  
**1. ASSIGN FUNCTION**

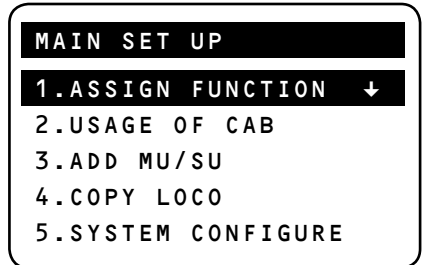

- 4) **a. LINK ADDR** - The link address for the locomotive must be chosen. This number is different for each locomotive and is a number from "00" to "49". The default entry, when you access the Assign Functions menu, is '49'. Use link address [00] for the first locomotive. Note that you can quickly move to link address [00] by pressing the STOP/ENTER key. To select another address, use the ◀ and ▶ keys until the address you want is displayed. This is also the method used to access previously defined locomotives for editing.

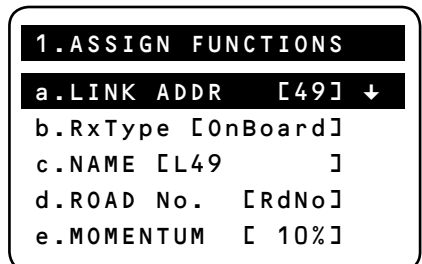

5) **c . NAME** – Use the ▲ and ▼ keys move to NAME. Use the keypad to type letters or numbers to name the locomotive. Names may be up to 9 characters long. There is a guide to entering names in Appendix “A” on page 35 of this manual.

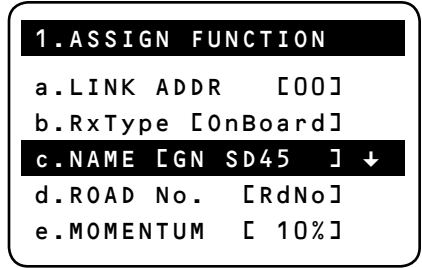

6) **d . ROAD NO .** – Use the ▲ and ▼ keys move to ROAD No. Enter a road number of up to four characters using the number keypad.

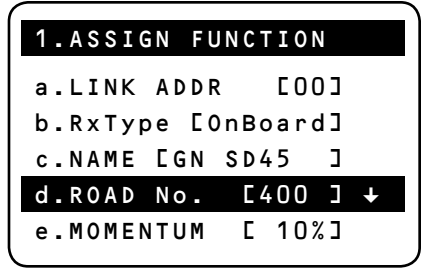

7) Place the locomotive on the track.

8) Apply power. If running on batteries make sure the locomotive’s battery is 12 to 24 volts and is fully charged. If using track power, apply 12 to 24 volts to the track.

9) **m . LINKING** – Use the ▲ and ▼ keys move to LINKING. Press and hold the Link Switch on the locomotive. Release the Link Switch when the locomotive’s lights begin flashing.

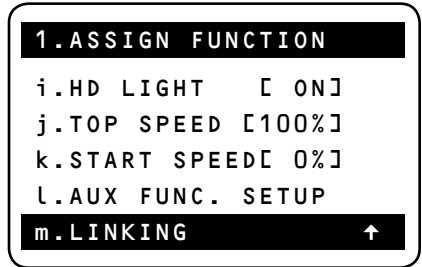

**NOTE:** There is an LED on the Revolution TE Receiver that also flashes during this linking process. See the illustration of the receiver, on page 7, to locate the LED.

While the lights (and LED) are flashing press the STOP/ENTER key on the transmitter.

In a moment the screen will show that the programming of the unit has been successful and the flashing will stop.

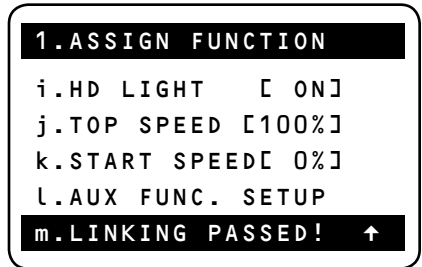

11) Press the MENU key once to return to the Main Menu.

**BASIC LOCOMOTIVE PROGRAMMING IS NOW COMPLETE.**

## Setting the CAB number

Each locomotive must be assigned to a cab number. This provides a simple way to choose locomotives from the main operating screen.

- 1) Press MENU to display the main set up menu.

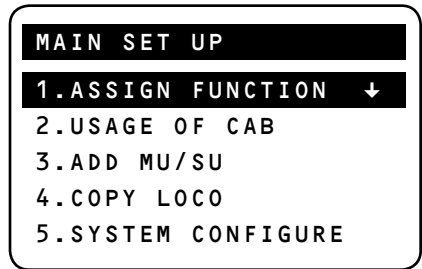

- 3) Press the 3 key to select:  
**3.ADD MU/SU**

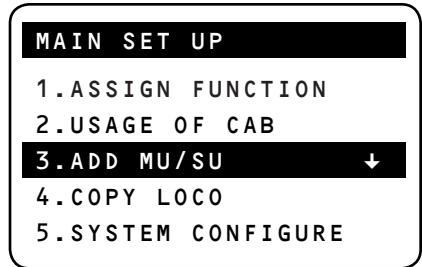

- 4) Use the ▲ and ▼ keys to select a CAB number. CAB-0 is the first available active locomotive in the list so you want to start here.

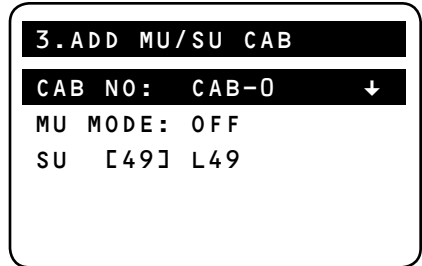

- 5) Use the ▲ and ▼ keys to select  
**SU [49] L49**

- 6) Use the ◀ and ▶ keys to scroll thru the locomotive listings until you find the locomotive (by Link Address) that you programmed previously. As shown in the example to the right for a GN SD45.

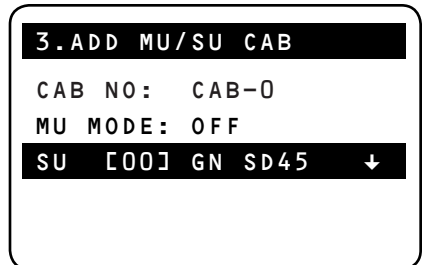

- 7) Press the MENU key to return to the Main Menu

**The transmitter and receiver are now linked and ready to operate your locomotive.** When you feel ready to move into advanced features and programming please turn to the advanced setup section in this manual.

## OPERATING YOUR LOCOMOTIVE

- 1) Use <<T and T>> keys to select the cab number that you assigned to the locomotive that you want to operate. The locomotive's name & road number will be displayed on the top line along with SU-, indicating that this is operating as a single unit locomotive.
- 2) Use the up and down arrow keys (▲ and ▼) to increase and decrease the locomotive's speed.
- 3) Use the Right Arrow key (▶) to go forward and the Left Arrow key (◀) to run backwards.

While it is preferred that you stop you trains gradually by using the down arrow (▼) key you can stop the selected locomotive quickly by pressing STOP/ENTER.

**You can now add additional locomotives** following these same procedures but using a different Link Address for each new locomotive.

### **Controlling two locomotives (trains) independently, at the same time**

- 1) Make sure that both locomotives have been identified in the transmitter, that linking has been successful and that the locomotives have each been assigned a Cab Number.
- 2) Place each locomotive on the track, separated by some distance .
- 3) Use the <<T and T>> keys until the display shows cab number, name and road number for the locomotive that is in front.
- 4) Use the UP Arrow (▲) key to start it running slowly in a forward direction.
- 5) Select the other locomotive with the <<T and T>> keys. Use the ▲ and ▼ keys to get it running.

Note that the displayed speed for both locomotives may not be the same when they are actually running at the same speed as it can vary from locomotive to locomotive.

You can continue to operate each locomotive independently by switching from one CAB to the other using the <<T and T>> keys and then make changes in speed or operate accessories.

**That is all there is to get up and running.** With practice you will become a master at controlling your trains. When you are ready to take the next step please read the advanced section of this manual to learn how to make the most of the Revolution TE.



## BASIC OPERATING TROUBLESHOOTING

### *“The engine runs backwards when the transmitter is set to forward”*

- 1) Press MENU to display the MAIN SET UP menu.
- 2) Press the STOP/ENTER key to select:  
**1 . ASS I G N   F U N C T I O N**
- 3) Use the ▲ and ▼ keys to scroll down the list of functions to:

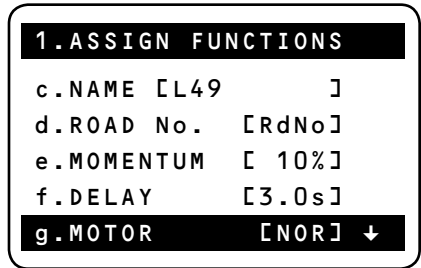

- g . M O T O R**
- 4) Use the ◀ and ▶ keys to toggle motor direction between **N O R**mal and **R E V**erse.
  - 5) Press MENU to exit to the main menu screen.
  - 6) Press MENU again to exit to the operating screen.

The locomotive will now respond to direction in the opposite way that it did initially and should now match the transmitter indication.

### *“My engine’s headlight does not match the direction of the locomotive”*

- 1) Press MENU to display the main set up menu.
- 2) Press the STOP/ENTER key to select:  
**1 . ASS I G N   F U N C T I O N**
- 3) Use the ▲ and ▼ keys to scroll down the list of functions to:

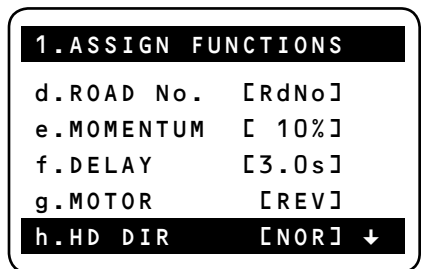

- h . H D   D I R**
- 4) Use the ◀ and ▶ keys to toggle the headlight direction between **N O R**mal and **R E V**erse.
  - 5) Press MENU to exit to the main menu screen.
  - 6) Press MENU again to exit to the operating screen.

The headlight will now match the direction of travel of your locomotive.

# ADVANCED OPERATIONS, INSTALLATIONS AND PROGRAMMING

## AUXILIARY CONTROL HARNESS

An Auxiliary Control Harness is supplied with the Revolution TE Receiver. The Auxiliary Control Harness plugs into a seven pin auxiliary wiring connector at one end of the receiver circuit board. The wires, which correspond to keys 1 thru 6 on the transmitter, are connected to control functions of your choice.

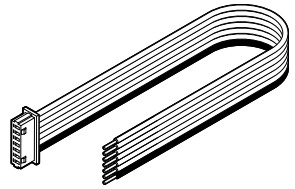

**NOTE:** The functions listed in the table below represent how we envisioned the system to operate. This does not mean to say that this is the only way that you can use each of the six functions. More important is that you assign a purpose to each auxiliary function and stay consistent from one locomotive to the next so that you know which key does what on each of your locomotives.

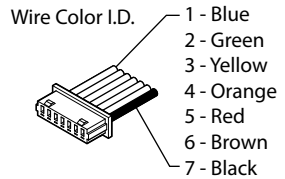

The six switch positions will need to be connected to the accessory you wish to control with the Transmitter. Please refer to the manufacturer's instructions for connecting sound triggers when using third party sound systems.

The six functions of the Auxiliary Control Harness are independently programmable and intended to operate as follows:

AUXILIARY CONTROL HARNESS				
Wire #/Color	Tx Key	Typical Use		Setting
1	Blue	1	Horn/Whistle sound	Momentary
2	Green	2	Bell sound	Latching
3	Yellow	3	Brake sound	Momentary
4	Orange	4	Other sound	Momentary
5	Red	5	Running/Cab/Ditch Lights	Latching
6	Brown	6	Smoke (use with CRE57073 Smoke Control Board)	Latching
7	Black	N/A	Common (ground) for all functions	

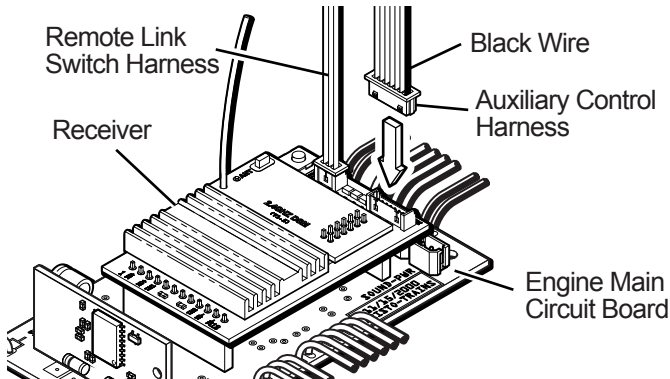

## CRE57073 SMOKE CONTROL BOARD

In order to control a smoke generator which has a relatively high power draw, a Smoke Control Board (Available separately CRE57073) has been designed to work with the Revolution TE Receiver. This Smoke Control Board has been designed to be used with the Auxiliary Control Harness to remotely operate smoke generators by acting as an electronic switch or relay. The Smoke Control Board has the ability to operate two smoke generators simultaneously.

- 1) If you use heat shrink tubing to insulate solder joints, place a short piece on the black wire and another on the brown wire of the Auxiliary Control Harness. Solder the black wire from the Smoke Control Board to the black wire in the Auxiliary Control Harness. Solder the white wire from the Smoke Control Board to the brown wire on the Auxiliary Control Harness. Carefully heat the heat shrink tubing (or use electrical tape) to insulate the solder joints.

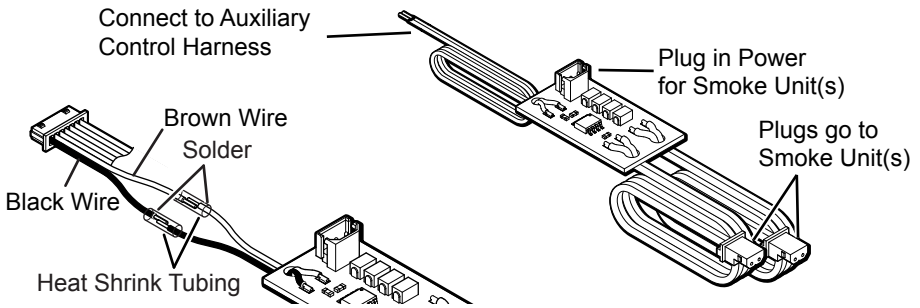

- 2) Unplug the wire harness that is plugged into the smoke generator in your locomotive and plug this connector into the socket on the Smoke Control Board. If your locomotive has dual smoke generators, like the Aristo-Craft E8, unplug both smoke units and plug only one of these connectors into the Smoke Control Board.
- 3) Plug one of the connectors from the Smoke Control Board (either one will work) into the smoke generator, where the original connector was plugged in. If you have a second smoke generator in your locomotive, plug the other connector from the Smoke Control Board into the second smoke unit.
- 4) Use double sided foam tape to securely mount the Smoke Control Board to the interior of the locomotive using care that the circuit board does not come in contact with any metal inside of the locomotive.
- 5) Set the smoke switch (in the locomotive) to on. This switch should remain on.
- 6) Refer to the Advanced Programming section of this manual to program F6 to 'LATCH' under AUX FUNC. SETUP in the locomotive ASSIGN FUNCTIONS menu.

The onboard Revolution receiver now has control of the locomotive smoke generator. When you want to operate the smoke generator in your locomotive, add smoke fluid to the smoke generator and when operating the locomotive, simply press key '6' to turn the smoke on and press key '6' again to turn the smoke off.

## ADVANCED PROGRAMMING AND FUNCTION INFORMATION

The following section is a comprehensive list of functions, displays and descriptions of the options available under each menu item. Accessing and setting these functions uses exactly the same techniques described in the basic programming section of this manual.

### The Transmitter Operating screen

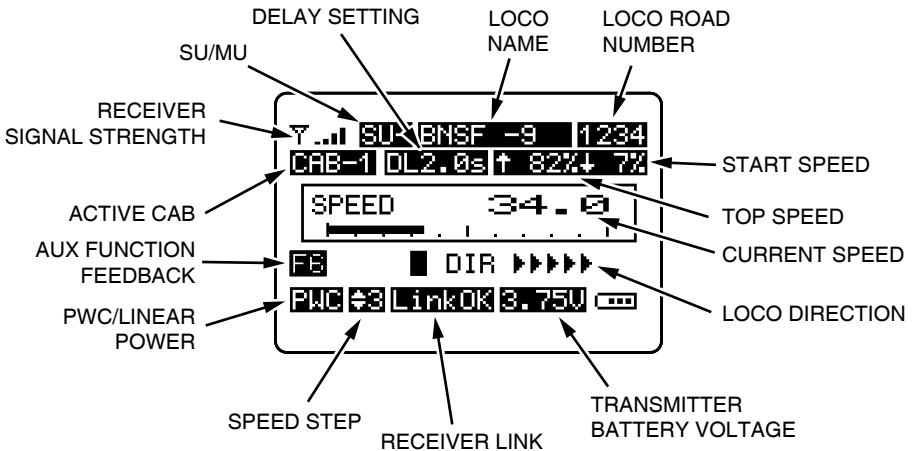

### OPERATING SCREEN - First Line

**Receiver Signal Strength** - The antenna symbol and signal bars, in the upper left corner of the screen shows the strength of the radio signal between the transmitter and the locomotive's receiver. This is reference information only and has no user settable function.

**SU/MU** - SU- indicates that the locomotive under control is a single independent unit. MU2 or MU3 indicates that a Multiple Unit configuration of 2 or more locomotives is being operated. This is also reference information and it indicates the selected CAB type.

**Loco Name** - The active locomotive's name is programmed by the operator when programming locomotives

**Loco Road Number** - The active locomotive's road number is programmed by the operator when programming locomotives

### OPERATING SCREEN - Second Line

**Cab #** - The cab number is associated with the locomotive that is being controlled. This number is programmed by the operator under item 3 of the main menu ADD MU/SU CAB which is used to assign either single locomotive or multiple locomotives to a CAB Number for operating purposes. This is what makes MUed locomotives work as a unit.

**Delay Setting** - Is the number of seconds that the train will stay stopped when its direction is changed. DL2.0s in this example means that the locomotive will pause for 2.0 seconds before it reverses direction. This setting is available for programming by the operator when a locomotive is being defined under Item 1, ASSIGN FUNCTIONS

**Top Speed** - The locomotive's maximum speed is expressed as a percentage of the maximum possible speed. This setting is available for programming by the operator when a locomotive is being defined under Item 1, ASSIGN FUNCTIONS. TOP SPEED is useful when the operator would like to limit the maximum speed of a locomotive to a scale speed for realistic operation. This item can also be useful if you wish to limit the speed at which children operate a locomotive.

**Start Speed** - The locomotive's start speed is expressed as a percentage of the amount of power required for the locomotive to begin to move. This setting is available for programming by the operator when a locomotive is being defined under Item 1, ASSIGN FUNCTIONS. START SPEED is used to reduce the dead zone between speed setting 0 and the speed setting at which the locomotive begins to move.

### **OPERATING SCREEN - Current Speed Box**

**Current Speed** - shows the locomotive's current speed as a percentage of the maximum possible speed. At the bottom of this box the speed of the locomotive is shown graphically in the form of a bar.

### **OPERATING SCREEN - Loco Direction Line**

**Loco Direction** - shows the direction of travel for the active locomotive. Arrows pointing to the right indicate forward while arrows pointing to the left indicate reverse

**Aux Function Feedback** - Flashes when an Auxiliary Function key is pressed.

### **OPERATING SCREEN - Bottom Line**

**PWC/Linear Power** - The first item on the bottom line shows that the system is using PWC (Pulse Width Coding) speed control.

**Speed Step** - This shows the sensitivity level for speed of reaction after pressing the ◀ and ▶ keys. This is an operator defined setting under the QUICK MENU LIST. For switching you might want a lower sensitivity and for big trains a faster key reaction. This setting is applied to all locomotives being controlled by the transmitter.

**LinkOK or NOLink** - tells whether the transmitter and receiver of the active locomotive are communicating. This same area on the display will show error messages such as **OVERLOAD** or **OVERHEAT**. This is reference information only and has no user settable function.

Normally the transmitter's main control display shows LinkOK on the bottom line of the screen. This indicates that there is a good radio link between the transmitter and the receiver in the locomotive. If that link is lost due to an



## MENU FUNCTIONS AND NAVIGATION

In this section each menu item is shown along with comments about its use.

The MAIN SET UP menu is accessed by pressing MENU from the main control screen. To navigate this menu use the ▲ and ▼ keys to select the item that you wish to edit and press ENTER to access the item submenu.

- 1. ASSIGN FUNCTION** – This Menu is used to define individual locomotives. To navigate this menu use the ▲ and ▼ keys to select the function that you wish to change. To change a setting that has a pre-defined range, use the ◀ and ▶ keys. Under NAME and ROAD NO. Use the number and letter keys to add text and numbers. When programming is complete, press Menu to return to the Main Menu.

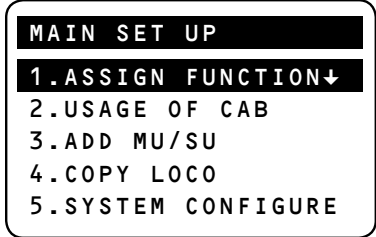

After a new locomotive is defined in this Menu, you must then assign the new locomotive a Cab Number in Menu 3.ADD MU/SU CAB, before you can control your newly defined locomotive.

## FUNCTION SETTINGS

- a. LINK ADDR** - The link address for the locomotive must be chosen. This number is different for each locomotive and is a number from “00” to “49”. Use the ◀ and ▶ keys to select a Link Address. 00 is the first available address in the list and should be used for the first locomotive. Note that you can quickly move to address 00 by pressing the STOP/ENTER key.

- b. RxType** - This menu item tells the transmitter which type of receiver is being defined. OnBoard is the receiver type used in locomotives while BASE RX is the receiver type used for stationary functions such as remote switch control. Use the ◀ and ▶ keys to select the Receiver Type that you are defining. Once linked, the receiver type cannot be changed without relinking.

- c. NAME** – This is where you give your locomotive an easy to identify name. Use the keypad to type letters or numbers to “Name” the locomotive. Names may be up to 9 characters long. Something like BNSF GP40 or UP -9 or some similar description is good. There is a guide to entering text in Appendix “A” (page35).

- d. ROAD NO.** – Enter the road number of the locomotive being defined. One to four characters is allowed. This lets you distinguish between two locomotives that were both named BNSF GP40 for example.

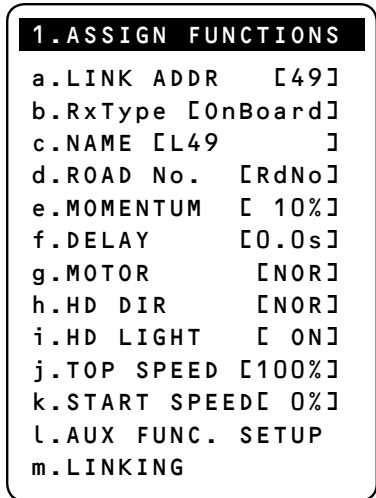

- e . MOMENTUM** - If momentum is set to 0 (zero) your locomotive will accelerate rapidly if you press and hold the UP ARROW key. Its speed will instantly become what it is set to. As the momentum setting is increased the time that it takes the locomotive to catch up with the speed setting you set increases. This means that you can set the speed to 60% by holding the UP ARROW key for a few seconds but the locomotive may take several more seconds to actually make it to that speed. Use the ◀ and ▶ keys to select the amount of Momentum that you want to apply to the locomotive you are defining.
- Momentum And Step Speed** (described later) both effect how quickly a locomotive will reach its top speed.
- f . DELAY** - When the direction of the locomotive is reversed this setting determines how long, in seconds, that the locomotive will be completely stopped before it starts up again in the other direction. The range is 0 to 5 seconds in 1/10th second increments. Use the ◀ and ▶ keys to select the amount of delay, in seconds, that you want your locomotive to wait before reversing direction.
- g . MOTOR** - This item sets the default direction of travel when the transmitter says the locomotive is going forward. This can be set to NOR (normal) or REV (reverse). If set to NOR the locomotive will go forward when the transmitter shows that it is going forward. If set to REV the locomotive will go backwards when the transmitter shows that it is going forward. This is used primarily when you are operating multiple locomotives (MUing) and you want them to run back-to-back. Use the ◀ and ▶ keys to select the Motor default direction.
- h . HD DIR** - This can be set to NOR (normal) or REV (reverse). If set to NOR the headlight on the locomotive will come on when the locomotive is going forward. If set to REV the headlight will come on when the locomotive is going backwards. This is useful if your headlights do not match the direction of travel of the locomotive. Use the ◀ and ▶ keys to change the headlight direction.
- i . HD LIGHT** - This can be set to ON or OFF. If set to ON the headlight will operate normally. If set to OFF the headlight will not function. This function is used when adding locomotives into a Multiple Unit consist. Typically only the lead locomotive has it's headlight on when operating and all trailing units have their headlights off. Use the ◀ and ▶ keys to set the headlight to On of Off.
- j . TOP SPEED** - Sets the locomotives top speed as a percentage of its possible top speed. This comes in handy if you have visitors who are operating your trains and have been known to run them at too high a speed. If you set this to 70% that is all the faster the locomotive will go, 70% of its possible top speed. Use the ◀ and ▶ keys to set the locomotives Top Speed.
- k . START SPEED** - Sets the speed at which acceleration of the locomotive begins. If you have a large locomotive or one that is pulling a long, heavy train you can set the start speed so that the power level will jump to the set percentage as soon as you begin accelerating. For example, if you have a locomotive that doesn't start moving till the throttle setting is at 25% you can set the start speed to that number and not have to wait for the speed to get to that level before the train moves. As soon as you press the UP ARROW key the speed will jump to 25%



and increase from there as the UP ARROW key is held. Use the ◀ and ▶ keys to set the Start Speed of the locomotive.

**l . AUX FUNC . SETUP** - This menu item is used to set each of the function keys to operate either as momentary or latching. **MOMENTARY** means that the function being controlled is on while the Function key is pressed and turns off when the key is released. **LATCHING** means that the function being controlled is turned on when the Function key is pressed and remains on till the same Function key is pressed again.

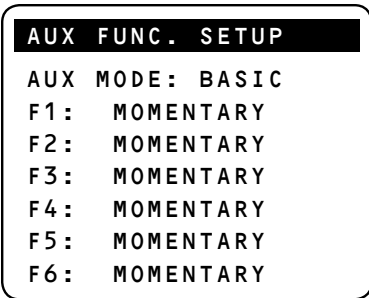

**AUX MODE: BASIC vs. EXTEND**

- Select either **BASIC** or **EXTEND**. In **BASIC** mode, you will be able to control function keys F1 thru F6. If your receiver supports more than six auxiliary functions then **EXTEND** mode is chosen so that you can control up to 16 auxiliary functions, F1 thru F16.

Use the ◀ and ▶ keys to set each Aux Function to either momentary or latching.

**m . LINKING** - This final menu item is used to establish a Link between the transmitter and the receiver that you just defined.

- 1) Press and hold the Link Switch on the receiver or locomotive until the LED on the receiver, or lights on the locomotive, begin to flash.
- 2) While the LED/lights are flashing press the ENTER key on the transmitter.

In a moment the screen will show that the programming of the unit has been successful and the flashing will stop. Once linked, the function settings are saved for this locomotive. Press MENU to return to the Main Menu.

## 2.USAGE OF CABS

The Revolution transmitter can store up to as many as 50 locomotives. Since it is unlikely that each of us would have this number of locomotives active at one time you can use this menu item to limit the number of locomotives that show up when you press the <<T and T>> keys while viewing the control screen.

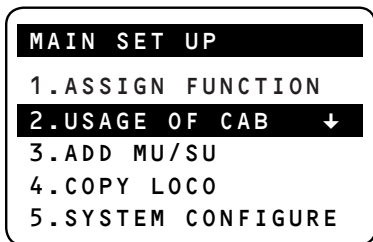

- 1) From the Main Menu screen use ▲ and ▼ to select **2.USAGE OF CABS** and press ENTER
- 2) Use the ◀ and ▶ keys to increase or decrease this range from **CAB-0** thru **CAB49**.

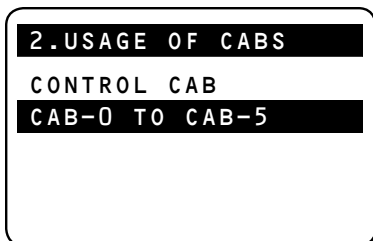

Press MENU to save this set-up and return to the Main Menu.

### 3.ADD MU/SU CAB

This Menu is used each time a new locomotive is added to the transmitter. Its purpose is to assign a Cab Number a locomotive so that it can be quickly identified and selected from the main operation screen. This is where you assign a locomotive it's Single Unit (SU) Cab Number and where you set up consists of up to six locomotives and assign them Multiple Unit (MU) Cab Numbers.

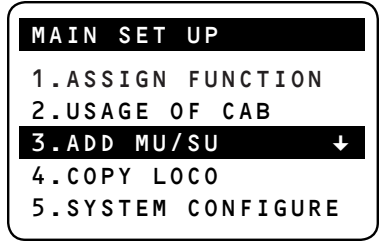

#### Single Unit (SU) Cab assignments

- 1) Use the ◀ and ▶ keys to choose a Cab Number to assign to a locomotive. This range is set by 2.USAGE OF CABS.
- 2) Make sure that MU MODE: is set to OFF for SU mode.
- 3) Use the ◀ and ▶ keys to select your locomotive, under SU by the Link Address assigned in 1.ASSIGN FUNCTIONS.
- 4) Press MENU to save this set-up and return to the Main Menu. Press MENU again to return to the operating screen.

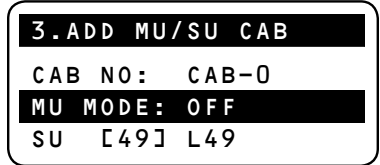

#### Multiple Unit (MU) Cab assignments

- 1) From the Main Menu screen use ▲ and ▼ to select 3.ADD MU/SU CAB and press ENTER
- 2) Use the ◀ and ▶ keys to choose a Cab Number to assign to the Multiple Unit (MU) consist. This range is set by 2.USAGE OF CABS.
- 3) Use the ◀ and ▶ keys to change MU MODE to ON. The menu changes to allow you to enter a list of locomotives that are to be MUed.
- 4) Select the first (lead) locomotive as MU1 by using ◀ and ▶ keys to select the Link Address assigned to it. Use the ▼ key to move to the next locomotive.
- 5) Select the second locomotive in the consist as MU2 by using ◀ and ▶ keys to select the Link Address assigned to it. Use the ▼ key again to move to the next locomotive.
- 6) Continue the MU assignments until all of the locomotives (up to a maximum of 6) that you want to MU in a single consist, are listed.
- 7) Press MENU to save this set-up and return to the Main Menu. Press MENU again to return to the operating screen.

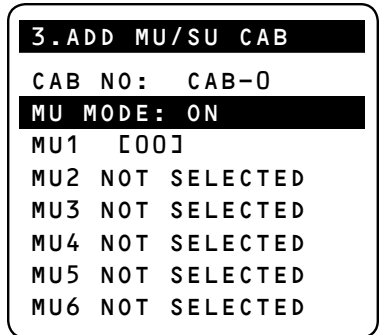

## **Operating multiple locomotives in consists (MUing)**

Once the set-up is complete, operating MUed locomotives is quite simple.

### **THE MU SET UP:**

For this example let's say that you set up two locomotives are called LOCO1 and LOCO2 and that their Cab Addresses are set to CAB-0 and CAB-1 respectively (LOCO1 is CAB-0 and LOCO2 is CAB-1).

Since the two locomotives can operate independently as CAB-0 and CAB-1 you set up CAB-2 for them to operate together in an MU consist.

In order to make sure that both locomotives are going to work in harmony, place both locomotives on the track a few feet apart. On the operating screen, select the MU on CAB-2 with the <<T and T>> keys.

Speed up the locomotives and confirm that both are going in the same direction. If you want one locomotive to run backwards you can make that change under 1.ASSIGN LOCOMOTIVE, a.MOTOR [REV].

### **THE OPERATION SCENARIO:**

You want to make up an MU consist in order to haul the daily freight west.

First, you operate LOCO1 in SU mode (CAB-0) and spot it at the assigned location in the yard. Stop LOCO1 by bringing the speed down to 0%.

Next, Select CAB-1 (LOCO2) on the transmitter, and operate LOCO2 in SU mode to meet LOCO1. You then couple LOCO2 to LOCO1 automatically and stop it, bringing LOCO2's speed to 0%.

You then select CAB-2 (MU LOCO1 & LOCO2) and now you operate the MU as a single unit. You pick up your assigned train in the yard and off you go to your assigned destination.

You now arrive at your destination and you bring your train to a full stop. You uncouple the lead locomotive (LOCO1), select CAB-0 and go off to the next assignment. Meanwhile LOCO2 is on yard duty to classify the cars it just delivered. You change to CAB-1 and work the yard with LOCO2 until all of the cars have been sorted.

### **NOTES:**

For more than 2 locomotives in a consist just add additional locomotives to CAB-2 under 3.ADD MU/SU CAB. Up to six locomotives may be MUed together into a single consist.

You can use the number key labeled "\*" (star) to select from the locomotive names in a consist so that you can access their accessory functions independently. For example, if you have a smoke unit in both LOCO1 and LOCO2 and each is attached to Auxiliary output #6 you could turn on the smoke in LOCO1 when the display shows LOCO1 at the top. To access the smoke unit on LOCO2 you would press the "\*" (star) key and LOCO2 would be displayed. Now button 6 will activate LOCO2's smoke unit.

## 4.COPY LOCO

Once you set up a locomotive with a set of options you can copy that locomotive's settings to use for another locomotive without having to re-enter all of the settings. For example, if you have set up an SD45 locomotive on link address 00 and want to copy the settings to link address 01 because you have another SD45 to set up:

- 1) From the Main Menu select 4.COPY LOCO and press ENTER
- 2) On the FROM: line use the ◀ and ▶ keys to select Loco 00 (or any defined locomotive in your transmitter)
- 3) On the TO: line use the ◀ and ▶ keys to select Link Address 01 (or any other Link Address of your choice)
- 4) Scroll down to COPY: Confirm that the FROM and TO entries are correct and press ENTER to confirm the copy.

Press MENU to return to the Main Menu.

**CAUTION:** Copying a locomotive to a Link Address that has previously been defined will overwrite all existing settings for that Link address.

### MAIN SET UP

- 1.ASSIGN FUNCTION
- 2.USAGE OF CAB
- 3.ADD MU/SU
- 4.COPY LOCO ↓
- 5.SYSTEM CONFIGURE

### 4. COPY LOCO

FROM: [00] L00  
TO: [01] L01  
COPY: [00]->[01]

## 5.SYSTEM CONFIGURE

This Menu gives you the ability to customize your transmitter to suit your preferences.

- 1) From the Main Menu screen select 5.SYSTEM CONFIGURE and press ENTER
- 2) Highlight POWER OFF and use the ◀ and ▶ keys to change the time, from 1 to 30 minutes, that you want the transmitter to stay on after the last key was used. This will help conserve transmitter battery power.
- 3) Scroll down to BRIGHTNESS and use the ◀ and ▶ keys to change the brightness of the LCD Screen backlight from 0 to 100%.
- 4) Scroll down to CONTRAST and use the ◀ and ▶ keys to change the Contrast of the LCD Screen from 0 to 100%.
- 5) Scroll down to KEY SOUND and use the ◀ and ▶ keys to turn the key (chirp) sound ON or OFF.

Press MENU to return to the Main Menu.

### MAIN SET UP

- 1.ASSIGN FUNCTION
- 2.USAGE OF CAB
- 3.ADD MU/SU
- 4.COPY LOCO
- 5.SYSTEM CONFIGURE

### 5.SYSTEM CONFIGURE

a.POWER OFF [ 5min]  
b.BRIGHTNESS [ 50%]  
c.CONTRAST [50%]  
d.KEY SOUND [ON ]

## 6.RADIO CONFIGURE

This menu has two settings available, RF-CHANNEL and GROUP ID.

RF-CHANNEL - All Revolution transmitters are factory set to channel 16. In most cases this can be left as is but if you suspect that interference from a local source is effecting the range of YOUR system, you can choose a new channel to help eliminate the interference. Note that you must relink any locomotives that you have if you change the RF Channel number.

GROUP ID - If you have more than 50 locomotives that you want to control or you have multiple areas that you want to control with separate transmitters, you can select a different Group ID for each transmitter and they will operate independently of one-another. It is also important that visitors who might bring their own Train Engineer Revolution and locomotives have a different group ID. Group ID numbers are set randomly at the factory so duplication should not be a problem and you may never have to change this setting. Note that you must relink any locomotives that you have if you change the Group ID number.

- 1) From the Main Menu screen select 6.RADIO CONFIGURE and press ENTER
- 2) When RF-CHANNEL is highlighted, use the ◀ and ▶ keys to change to the new RF-CHANNEL. Available Channels are channel 16 thru channel 26
- 3) Highlight GROUP ID and use the ◀ and ▶ keys to SELECT a new GROUP ID Number. The range for Group ID numbers is 0000 thru 9999

Press MENU to return to the Main Menu.

## 7.MY MEMO

This menu item is provided to allow you to personalize your transmitter so that the owner can be identified if it gets mixed up or left behind at a running session with other Revolution TE owners. Each field can contain up to 20 letters and/or numbers.

- 1) From the Main Menu screen select 7.MY MEMO and press ENTER
  - 2) Fill in your name and contact information.
- Press MENU to return to the Main Menu.

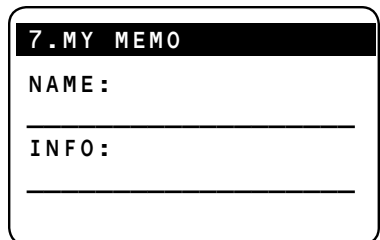
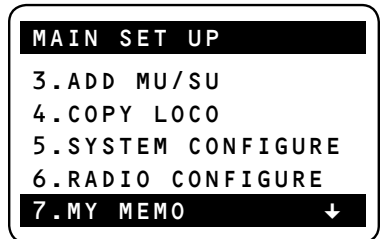
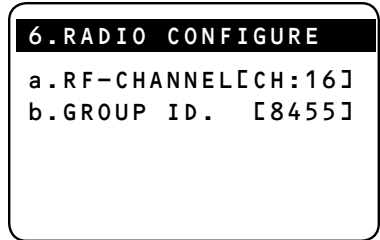
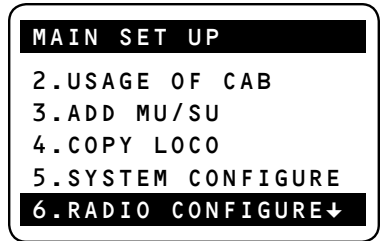

## 8. RESET MEMORY

This last item on the Main Menu is used to revert the transmitter back to the original factory software settings.

You have two choices, Yes or No.

**WARNING: THERE IS NO “UNDO”**, if you choose **YES** and then press **STOP/ENTER**, **ALL** user entered settings on the transmitter are erased.

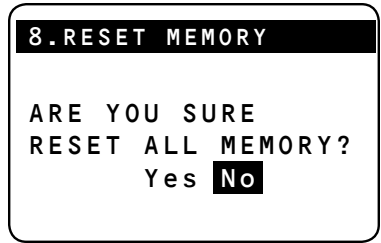

## QUICK MENU LIST

To access the QUICK MENU LIST, press the pound (#) key.

## AUX FUNCTIONS



This menu item, under the Quick Menu List, shows each Auxiliary Function and whether it is set to Latch or Momentary for the currently active locomotive. It also shows the current setting for each function. This is an easy way to see, for example, if your smoke unit is on or off.

You can also change the setting of each function (ON to OFF or OFF to ON) by highlighting the line and pressing ENTER

You cannot change the way that a key functions in this menu (momentary/latching), you must use the ASSIGN FUNCTIONS menu to make this change.

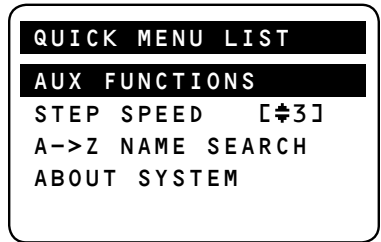

## STEP SPEED

Under this menu item, in the Quick Menu List, you can set the Step Speed. Step Speed is the setting that determines how fast locomotives accelerate (and decelerate) based on the number of increments required to go from 0 to full speed. The range is from 1 to 5. When set to 1 the rate at which the speed increases, when you hold the ▲ key will be the slowest. A higher number will increase the rate of

acceleration. For precise control of a locomotive, for switching operations, set the Step Speed to 1 or 2. To have your locomotives accelerate quickly, set it to 4 or 5.

When Step Speed is set to '1' each time you press the ▲ or ▼ Keys the speed changes by 0.1 %. When set to '2', the speed changes in increments of 0.5 %. A

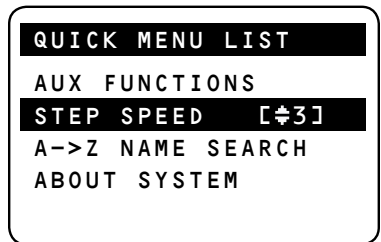

setting of '3' changes the speed by 1.0% each time the ▲ or ▼ Keys are pressed. A setting of '4' will increase speed by 2.5% and a setting of 5 jumps up or down by 5% each time the ▲ or ▼ Keys are pressed.

Step Speed Setting	Number of steps to go from 0 to 100%	Speed increment on each key press	Use
1	1000	1/10%	Very delicate operations
2	200	1/2%	
3	100	1%	Normal operations
4	40	2.5%	
5	20	5%	Rapid speed changes

### A->Z NAME SEARCH

This menu item is reference information only and shows an alphabetized list of all locomotives with road names and link addresses. This is a fast way to find the locomotive you want to operate. Use the ▲ and ▼ Keys to scroll through the list

A->Z NAME SEARCH		
2-8-2	7631	[04]
BNSF -9	1119	[02]
BNSF -9	1072	[05]
GN SD45	400	[06]
L07	RdNo	[07]

### ABOUT SYSTEM

This final item briefly displays the system frequency and software version number when you press STOP/ENTER.

Hold STOP/ENTER key to keep showing information

ABOUT SYSTEM
FRQ: 2.4GHz/US
Ver 1.14

### CUSTOM RECEIVER INSTALLATION

For custom installations, you will need the following items:

- Phillips head screwdriver
- 12 to 24 volt DC power source connected to the track or onboard batteries.
- A drill and drill bits to install the remote Link Switch (if desired)
- A soldering iron and solder
- Wire cutter and wire stripper
- Heat shrink tubing or electrical tape
- Electronic components for headlights

Many locomotives do not come equipped to accept the Revolution TE in a plug and play installation. In this case, the wiring of the locomotive will require modification

to accept the receiver. To facilitate custom installations, a Adaptor Plug is provided. The Adaptor Plug has a 12 position socket. Wire the Adaptor Plug to your locomotive with the connections as shown below.

- 1) **POWERING THE Revolution TE.** The Revolution TE is designed to work from either track power or on board battery power of at least 12 volts DC to a maximum of 24 volts DC. The receiver is self-protected for polarity and input current. However, if you use a battery, you should install a 3-amp fuse directly from the battery before any other wiring is connected. The fuse will protect your wiring and the battery from damage in case of an accidental short circuit.
- 2) **ISOLATE THE MOTOR(S).** The motor(s) **MUST** be isolated from ALL other wiring before the Revolution TE can be installed in a locomotive. This is critically important. Failure to isolate the motors will cause the receiver to malfunction or possibly fail. After you have located and disconnected the motor wires from the locomotive, use an ohmmeter to check the resistance between the motor wires and any other wires that you can find in the locomotive. If any connection is indicated at all, locate the connection and isolate the motor wires.
- 3) **ADAPTOR PLUG CONNECTIONS.** All wiring connections should be soldered and insulated with heat shrink tubing or electrical tape.

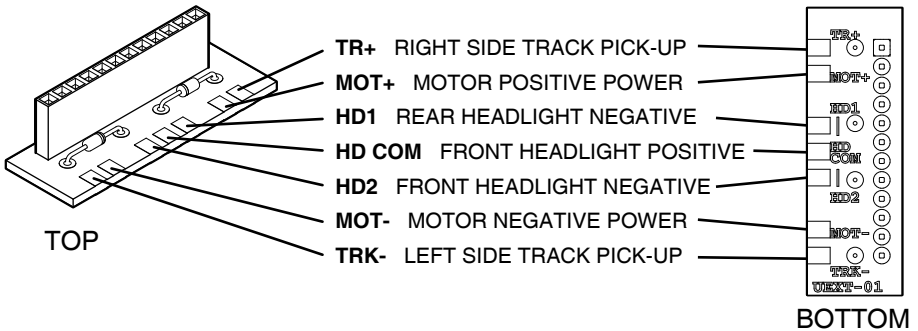

I.D.	USE	TRADITIONAL WIRE COLOR
TR+	RIGHT SIDE TRACK PICK-UP	Black (BLK)
MOT+	MOTOR POSITIVE POWER	Gray (GRY)
HD1	REAR HEADLIGHT NEGATIVE	Yellow (YEL)
HD COM	FRONT HEADLIGHT POSITIVE	Blue (BLU)
HD2	FRONT HEADLIGHT NEGATIVE	White (WHT)
MOT-	MOTOR NEGATIVE POWER	Orange (ORG)
TRK-	LEFT SIDE TRACK PICK-UP	Red (RED)

**Connect the motor wires:** Solder the motor’s Right Side terminal to the Adaptor Plug at MOT+. Solder the motor’s Left Side terminal to MOT-.

**Connect the power wires:** For track power installations, solder the Right Side power pick-ups to TR+. Solder the Left Side power pick-ups to TRK-. For Battery Power installations, Battery installations should include a 3-amp fuse in



line with the positive power connection to prevent damage to both the Revolution TE and the battery pack. Solder the Negative side of the battery pack to TRK-. Solder the Positive side of the battery pack to TR+.

**Connecting the Headlights:** The headlights will most likely require rewiring. All of the wiring to the headlights **MUST** be isolated from all other wiring. See the following wiring diagrams to connect the headlights in your locomotive.

HD2 is soldered to the Front headlight and is the negative power lead for the front headlight. HD1 is soldered to the rear headlight and is the negative power lead for the rear headlight. HD COM is soldered to both the Front and Rear Headlights and is the positive power lead for both front and rear headlights.

**Remaining connections:** You can now connect any remaining lights and smoke unit, that you want to control manually, to the power source (track pickups or battery) and control switches. If you want to control these functions remotely please see the Auxiliary Wiring Harness instructions (page 18) and Smoke Control Board instructions (page 19) for guidance.

**4) SECURING THE Revolution TE.** The Revolution TE should be located so that it is secure and insulated from any metal inside the locomotive. The Revolution TE can be attached to the shell or interior floor of the locomotive with double stick foam tape. Or the circuit board on the wire harness can be glued to the shell or interior floor, using silicone adhesive or hot melt glue.

**5) FINISHING THE INSTALLATION.** Refer to Step 4 (beginning on page 9) in the Receiver Installation instructions of this Manual to continue the receiver installation.

**6) PROGRAMMING THE LOCOMOTIVE.** Refer to Page 13 to program your locomotive in the Revolution TE Transmitter.

**Note:** The Revolution TE Receiver antenna may be extended when installed in a locomotive which has an all metal body. Generally, the exposed portion of the antenna (outside of the metal body) should be equal in length to the antenna supplied on the receiver and located as high as possible on the locomotive. You may have to make adjustments to your antenna for best reception. **DO NOT MODIFY THE ANTENNA WHEN INSTALLING THE TE RECEIVER IN PLASTIC BODY LOCOMOTIVES.**

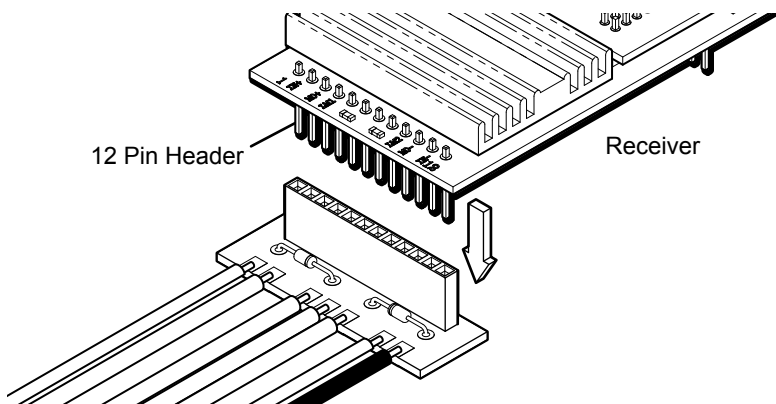

# WIRING DIAGRAM FOR INCANDESCENT HEADLIGHTS

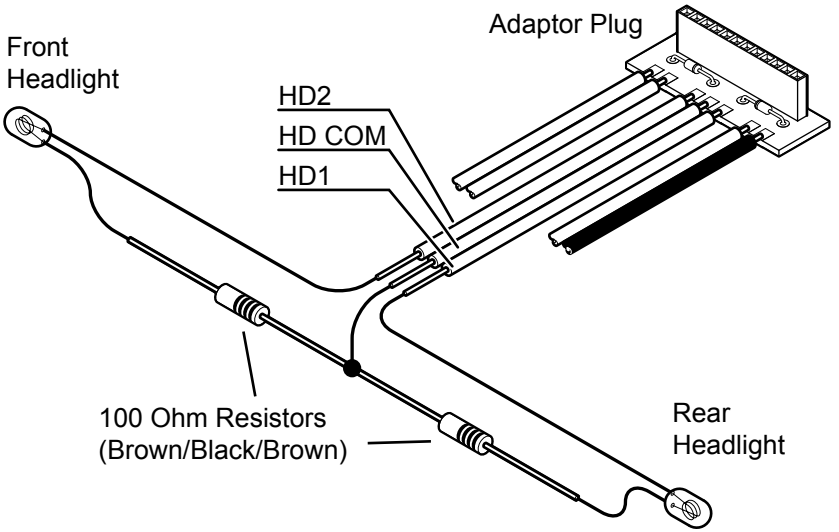

## Wiring For Dual Headlights

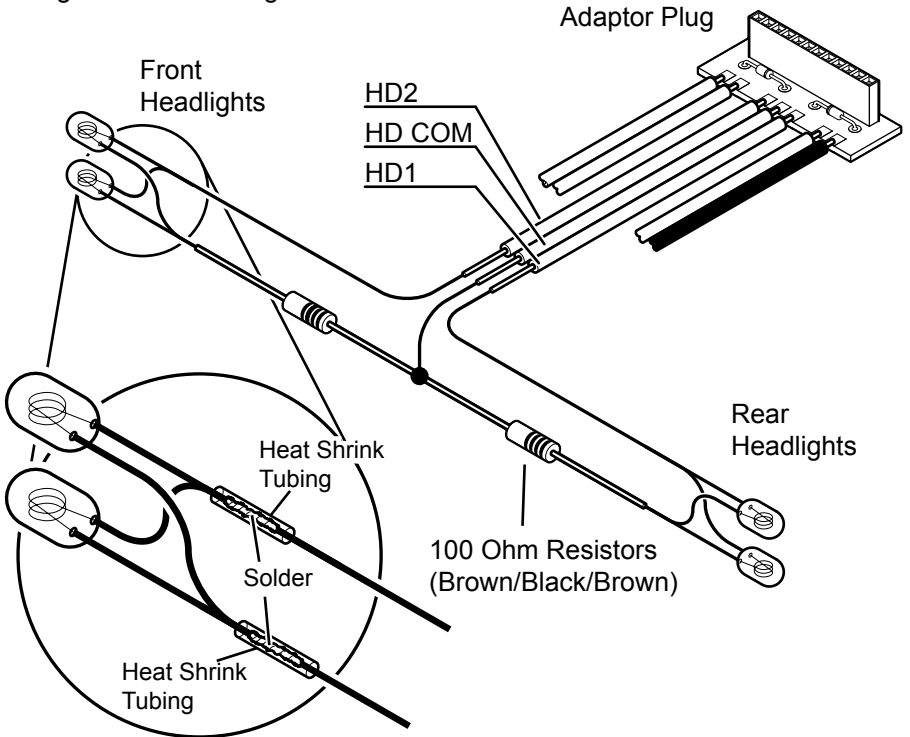

# WIRING DIAGRAM FOR LED HEADLIGHTS

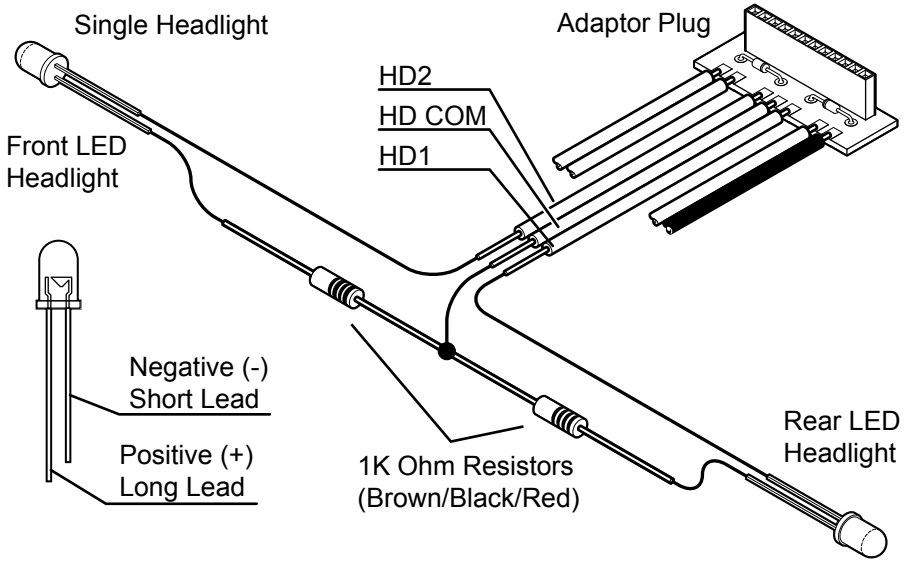

Typical Wiring For Dual Front and Rear LED Headlights

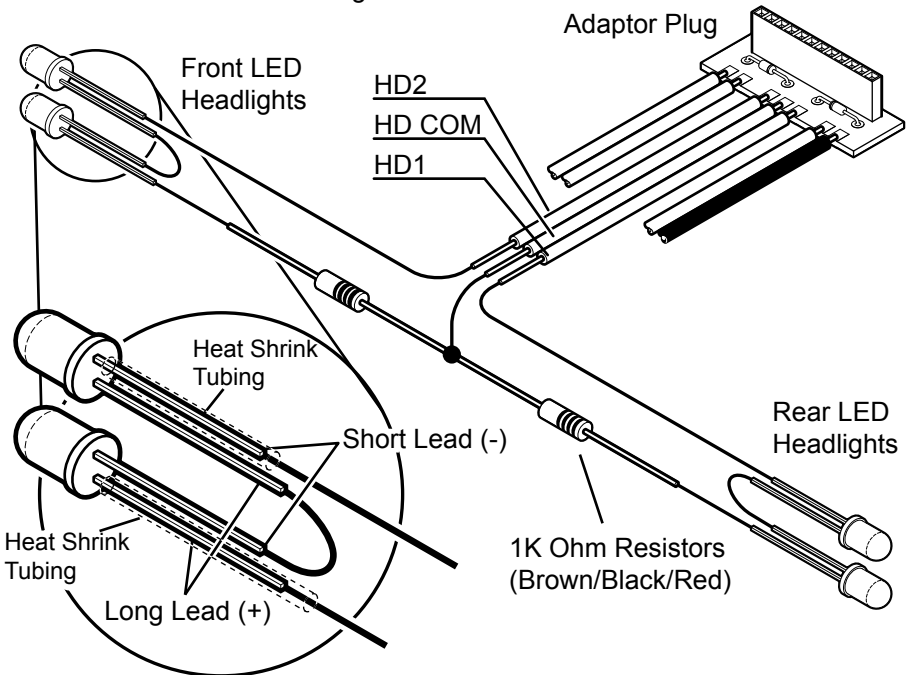

## Appendix “A” – Text entry with the transmitter’s keypad

Each number on the transmitter’s keypad is accompanied by three or four letters or characters. This arrangement allows us to quickly and easily enter numeric and textual information into the controller.

The method of entry is identical to that used on most cell phones. If you can enter names and phone numbers into your cell phone’s address book you can use text entry on the transmitter.

When you want to enter text, a locomotive’s name, for example, you can press a number key once to enter a number or you can press that key two or more times to cycle through the other available characters. Once the character you want appears on the screen pause for a bit over a second and the cursor will automatically move to the right for the next character. You can back up to make corrections with the left arrow key. You can move to the right with right arrow key.

Here is a list of each key and the number of times you must press it to get each character.

Key Pad	1st press	2nd press	3rd press	4th press
1 -&/*	-	&	/	#
2 abc	A	B	C	
3 def	D	E	F	
4 ghi	G	H	I	
5 jkl	J	K	L	
6 mno	M	N	O	
7 pqrs	P	Q	R	S
8 tuv	T	U	V	
9 wxyz	W	X	Y	Z
*	no character			
0 all stop				
#	space			

NOTES: \_\_\_\_\_  
\_\_\_\_\_  
\_\_\_\_\_  
\_\_\_\_\_  
\_\_\_\_\_  
\_\_\_\_\_  
\_\_\_\_\_  
\_\_\_\_\_

**LOCOMOTIVE:** \_\_\_\_\_ **DATE:** \_\_\_\_\_

a.LINK ADDR		j.TOP SPEED	
b.RxType		k.START SPEED	
c.NAME		L.AUX FUNC SU	
d.ROAD No.		F1	
e.MOMENTUM		F2	
f.DELAY		F3	
g.MOTOR		F4	
h.HD DIR		F5	
i.HD LIGHT		F6	

**LOCOMOTIVE:** \_\_\_\_\_ **DATE:** \_\_\_\_\_

a.LINK ADDR		j.TOP SPEED	
b.RxType		k.START SPEED	
c.NAME		L.AUX FUNC SU	
d.ROAD No.		F1	
e.MOMENTUM		F2	
f.DELAY		F3	
g.MOTOR		F4	
h.HD DIR		F5	
i.HD LIGHT		F6	

**LOCOMOTIVE:** \_\_\_\_\_ **DATE:** \_\_\_\_\_

a.LINK ADDR		j.TOP SPEED	
b.RxType		k.START SPEED	
c.NAME		L.AUX FUNC SU	
d.ROAD No.		F1	
e.MOMENTUM		F2	
f.DELAY		F3	
g.MOTOR		F4	
h.HD DIR		F5	
i.HD LIGHT		F6	

**LOCOMOTIVE:** \_\_\_\_\_ **DATE:** \_\_\_\_\_

a.LINK ADDR		j.TOP SPEED	
b.RxType		k.START SPEED	
c.NAME		L.AUX FUNC SU	
d.ROAD No.		F1	
e.MOMENTUM		F2	
f.DELAY		F3	
g.MOTOR		F4	
h.HD DIR		F5	
i.HD LIGHT		F6	

**LOCOMOTIVE:** \_\_\_\_\_ **DATE:** \_\_\_\_\_

a.LINK ADDR		j.TOP SPEED	
b.RxType		k.START SPEED	
c.NAME		L.AUX FUNC SU	
d.ROAD No.		F1	
e.MOMENTUM		F2	
f.DELAY		F3	
g.MOTOR		F4	
h.HD DIR		F5	
i.HD LIGHT		F6	

**LOCOMOTIVE:** \_\_\_\_\_ **DATE:** \_\_\_\_\_

a.LINK ADDR		j.TOP SPEED	
b.RxType		k.START SPEED	
c.NAME		L.AUX FUNC SU	
d.ROAD No.		F1	
e.MOMENTUM		F2	
f.DELAY		F3	
g.MOTOR		F4	
h.HD DIR		F5	
i.HD LIGHT		F6	

**LOCOMOTIVE:** \_\_\_\_\_ **DATE:** \_\_\_\_\_

a.LINK ADDR		j.TOP SPEED	
b.RxType		k.START SPEED	
c.NAME		L.AUX FUNC SU	
d.ROAD No.		F1	
e.MOMENTUM		F2	
f.DELAY		F3	
g.MOTOR		F4	
h.HD DIR		F5	
i.HD LIGHT		F6	

**LOCOMOTIVE:** \_\_\_\_\_ **DATE:** \_\_\_\_\_

a.LINK ADDR		j.TOP SPEED	
b.RxType		k.START SPEED	
c.NAME		L.AUX FUNC SU	
d.ROAD No.		F1	
e.MOMENTUM		F2	
f.DELAY		F3	
g.MOTOR		F4	
h.HD DIR		F5	
i.HD LIGHT		F6	

**LOCOMOTIVE:** \_\_\_\_\_ **DATE:** \_\_\_\_\_

a.LINK ADDR		j.TOP SPEED	
b.RxType		k.START SPEED	
c.NAME		L.AUX FUNC SU	
d.ROAD No.		F1	
e.MOMENTUM		F2	
f.DELAY		F3	
g.MOTOR		F4	
h.HD DIR		F5	
i.HD LIGHT		F6	

**LOCOMOTIVE:** \_\_\_\_\_ **DATE:** \_\_\_\_\_

a.LINK ADDR		j.TOP SPEED	
b.RxType		k.START SPEED	
c.NAME		L.AUX FUNC SU	
d.ROAD No.		F1	
e.MOMENTUM		F2	
f.DELAY		F3	
g.MOTOR		F4	
h.HD DIR		F5	
i.HD LIGHT		F6	

**LOCOMOTIVE:** \_\_\_\_\_ **DATE:** \_\_\_\_\_

a.LINK ADDR		j.TOP SPEED	
b.RxType		k.START SPEED	
c.NAME		L.AUX FUNC SU	
d.ROAD No.		F1	
e.MOMENTUM		F2	
f.DELAY		F3	
g.MOTOR		F4	
h.HD DIR		F5	
i.HD LIGHT		F6	

**LOCOMOTIVE:** \_\_\_\_\_ **DATE:** \_\_\_\_\_

a.LINK ADDR		j.TOP SPEED	
b.RxType		k.START SPEED	
c.NAME		L.AUX FUNC SU	
d.ROAD No.		F1	
e.MOMENTUM		F2	
f.DELAY		F3	
g.MOTOR		F4	
h.HD DIR		F5	
i.HD LIGHT		F6	



TM



TM